









24

	
	(0) 6033 / 9693-13 
	(0) 6033 / 9693- 0 
	(0) 6033 / 9693813
	(0) 6033 / 9693-40
	e-mail: k.hackel@kran-burgard.de
	e-mail: info@kran-burgard.de
	  ++49

Kran-Burgard GmbH
Otto Hahn Straße 18
D - 35510 Butzbach

ALL-TERRAIN ATF 70-4 KRAN-BURGARD

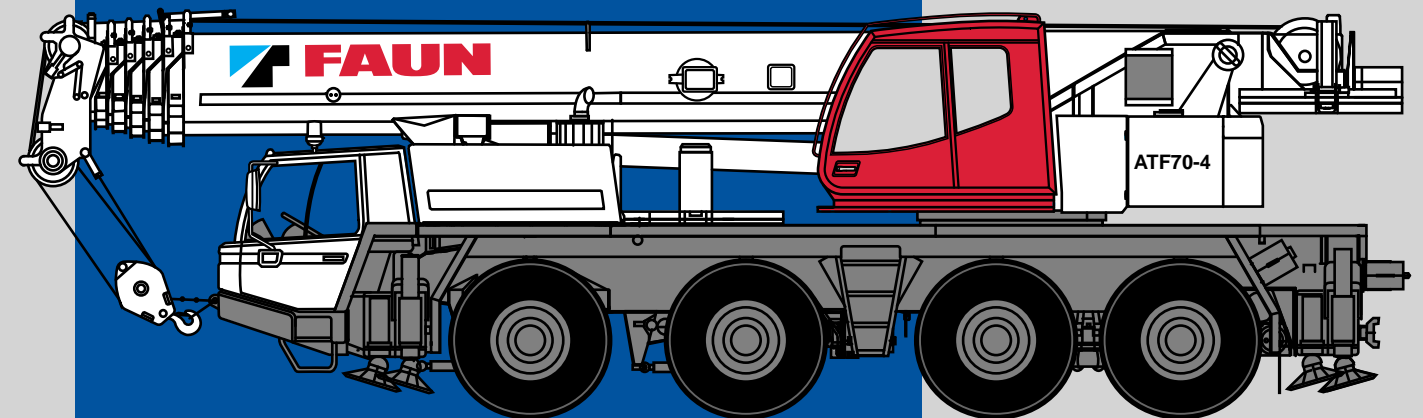

Maße (mm)
 Dimensions (mm)
 Dimensiones (mm)

 16.00 R 25

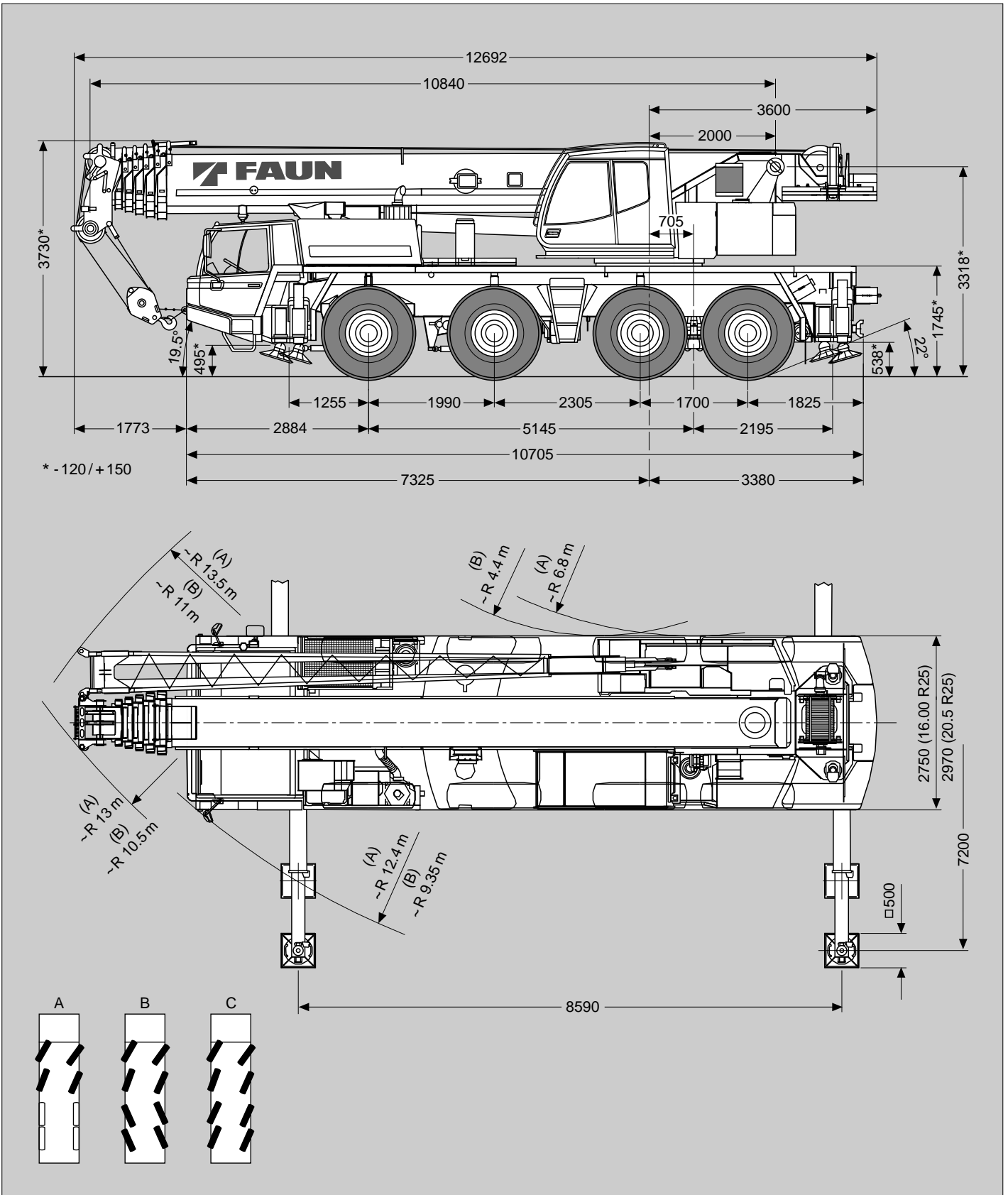

Tragfähigkeiten
Lifting capacities
Capacités de levage
Capacidades de elevación

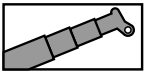

6t

DIN/ISO

↗ m	10.8 m	14.6 m	18.3 m	22.1 m	25.9 m	29.7 m	33.5 m	37.3 m	41.0 m	44.8 m	48.5 m
2.5	80.0*										
3.0	69.1	68.0	58.0	47.0							
3.5	59.4	59.4	58.0	45.0							
4.0	51.7	51.7	50.7	42.9	34.1						
4.5	45.7	45.7	44.8	40.9	33.2						
5.0	40.8	40.8	39.9	38.9	32.4	27.0					
6.0	33.4	33.4	32.6	32.0	30.6	25.4	21.0				
7.0	28.1	28.1	27.5	26.7	26.7	23.9	20.0	16.0	12.8		
8.0	23.8	23.9	24.8	22.3	22.6	22.3	19.1	15.4	12.8	10.0	
9.0		20.8	21.4	17.9	18.8	18.5	18.1	14.8	12.8	10.0	8.6
10.0		17.4	18.0	14.6	17.1	15.9	15.8	14.2	12.5	10.0	8.6
11.0		14.8	15.4	13.4	15.4	14.7	15.0	13.5	12.1	9.8	8.6
12.0		12.9	13.4	12.4	13.5	13.4	13.0	12.4	11.8	9.6	8.6
14.0			10.4	10.8	10.5	10.7	10.7	10.8	9.7	9.1	8.3
16.0			8.5	8.8	8.3	8.9	8.9	8.6	8.4	8.0	7.7
18.0				7.2	7.3	7.3	7.3	7.0	6.9	6.4	6.1
20.0				6.0	6.1	6.1	6.0	5.8	5.6	5.2	4.8
22.0					5.1	5.1	5.0	4.8	4.6	4.2	3.9
24.0						4.3	4.2	4.0	3.8	3.4	3.1
26.0						3.6	3.6	3.4	3.2	2.8	2.5
28.0							3.1	2.8	2.7	2.3	2.0
30.0							2.6	2.4	2.2	1.8	1.5
32.0								2.0	1.8	1.4	1.1
34.0								1.7	1.5	1.1	0.8
36.0									1.2	0.8	0.5
38.0									0.9	0.6	

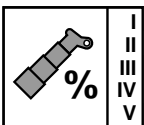

I	0	0/0	50/0/100/0	100/0/0	100/0/0	100/0/0	100/100/0/0	100/0/0	100/100/0	100/50	100
II	0	50/0	50/0/0/0	50/0/0	100/0/0	100/0/0	100/100/100/0	100/100/50	100/100/100	100/100	100
III	0	0/0	0/0/0/0	0/0/0	0/100/0	50/100/50	50/100/100/100	100/100/100	100/100/100	100/100	100
IV	0	0/0	0/50/0/0	0/100/50	0/50/100	0/100/100	50/0/50/100	50/100/100	50/100/100	100/100	100
V	0	0/50	0/50/0/100	0/50/100	0/50/100	0/50/100	0/0/50/100	0/50/100	50/0/100	50/100	100

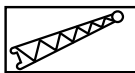
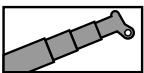

6t

DIN/ISO

↗ m	44.8 m + 9.0 m			48.5 m + 9.0 m			48.5 m + 16.0 m		
	5°	20°	40°	5°	20°	40°	5°	20°	40°
10.0	6.00								
11.0	5.85			5.50					
12.0	5.70	3.85		5.50					
14.0	5.35	3.60	2.45	5.30	3.70		3.10		
16.0	5.05	3.40	2.35	5.10	3.50	2.40	2.95		
18.0	4.75	3.20	2.30	4.90	3.30	2.35	2.75	1.70	
20.0	4.40	3.05	2.20	4.65	3.15	2.25	2.60	1.60	
22.0	4.10	2.90	2.15	4.00	3.00	2.20	2.40	1.55	1.00
24.0	3.55	2.75	2.10	3.20	2.85	2.15	2.20	1.45	1.00
26.0	2.90	2.65	2.05	2.55	2.75	2.10	2.05	1.40	0.95
28.0	2.30	2.50	2.00	2.00	2.20	2.05	1.90	1.30	0.95
30.0	1.85	2.05	1.95	1.55	1.75	1.95	1.80	1.25	0.90
32.0	1.45	1.60	1.75	1.15	1.35	1.50	1.65	1.20	0.90
34.0	1.10	1.25	1.35	0.80	0.95	1.10	1.30	1.15	0.85
36.0	0.75	0.90	1.00	0.50	0.65	0.75	0.95	1.10	0.85
38.0	0.50	0.60	0.70				0.70	0.95	0.85
40.0								0.65	0.80
42.0									0.60
44.0									
46.0									

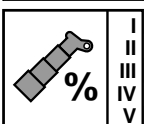

I	100 / 50			100			100		
II	100 / 100			100			100		
III	100 / 100			100			100		
IV	100 / 100			100			100		
V	50 / 100			100			100		

Hubhöhen
Lifting heights
Hauteurs de levage
Alturas de elevación

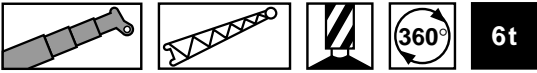

DIN/ISO

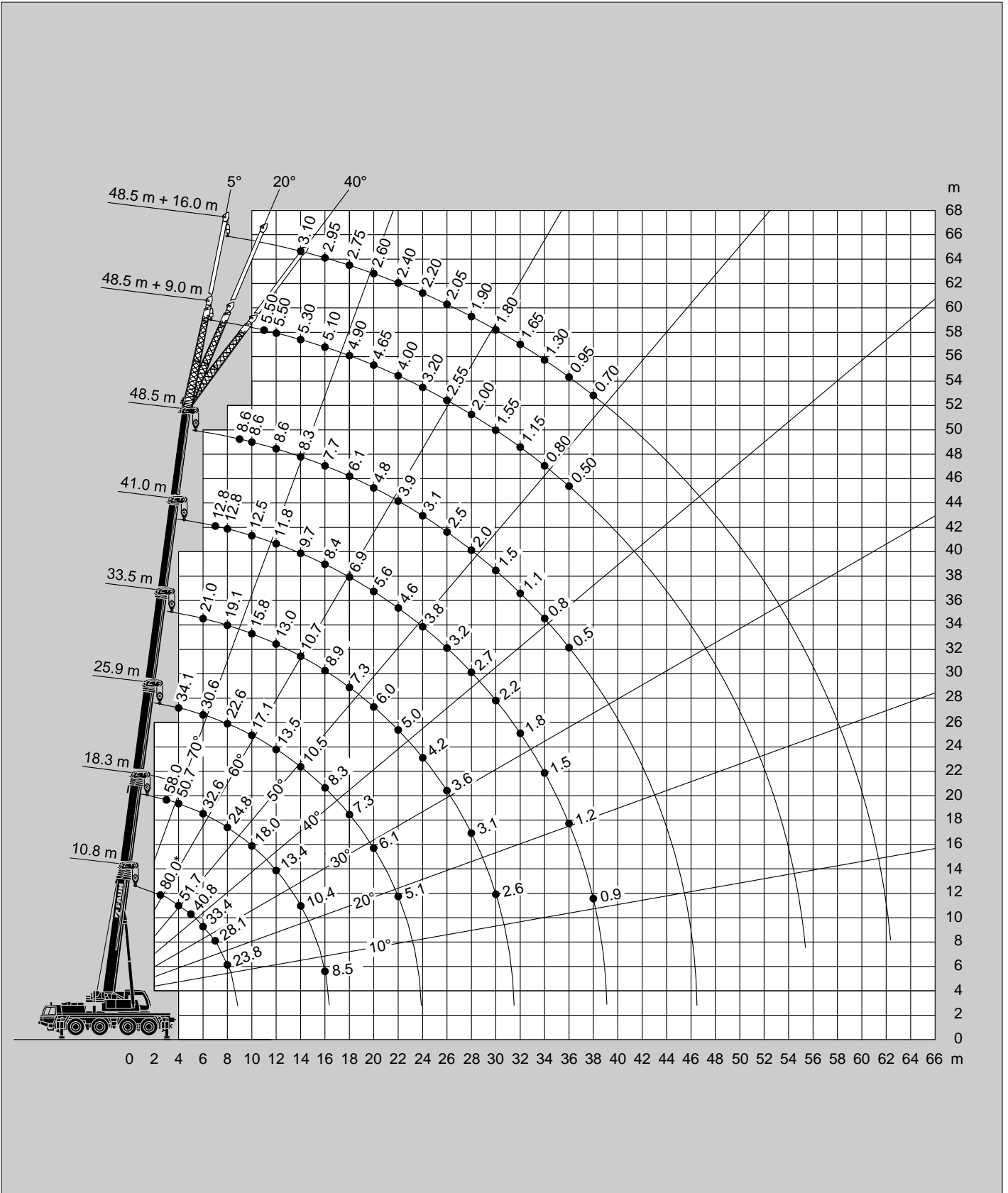

* Nach hinten mit Zusatzausrüstung / * Over rear with additional equipment / * A l'arrière avec équipement supplémentaire / * Sobre la parte trasera con equipo adicional

Hakenhöhen / Kopfhöhen
 Hook height / Tip height
 Hauteurs sous crochet / Hauteurs tête de flèche
 Altura del gancho / Altura de la punta

